



Operating instructions

(Translation of the original operating instructions)

CareMaster Wall 1

CareMaster Wall 2

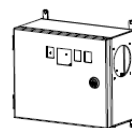
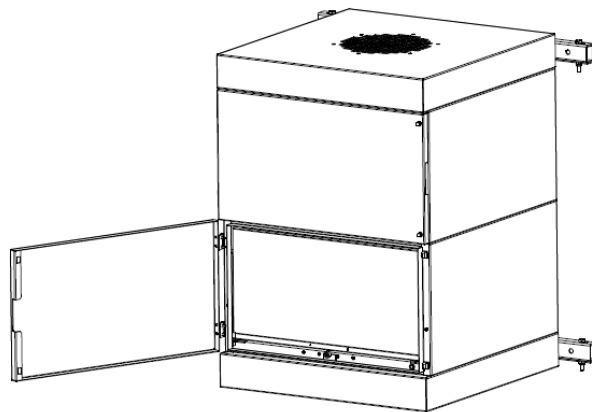



Table of contents

1. General	3
2. Description of the system elements	4
2.1. Illustration of the system elements	4
2.2. Functionality of the system	4
2.3. Intended use	5
2.4. Residual risk	5
3. Safety instructions	6
3.1. Definition of the hazard symbols	6
3.2. General safety instructions	6
4. Storage, transport and installation of the device	7
4.1. Mounting height	8
4.2. Mounting of the unit to the wall	9
5. Commissioning	10
5.1. Connecting an extraction element	10
5.2. Electrical connection	11
6. Operating the system	12
6.1. Explanation of the operating elements	12
7. Maintenance	13
7.1. Reset to maintenance state	13
7.2. Replacing the prefilter mat	14
7.3. Replacing the particle filter	15
8. Dismantling / Disposal	16
9. Diagnostics and troubleshooting	17
10. List of spare parts	18
11. Technical data	19
12. EC declaration of conformity	20
13. Training protocol	21
14. Maintenance intervals	22
14.1. Usage-related maintenance	22
14.2. General maintenance	22
14.2.1. Visual inspection of the device	23
14.2.2. Visual inspection of the pipelines for dust deposits	23
14.2.3. Visual inspection of the pneumatic pipes	24

1. General

Congratulations on purchasing the product from TEKA.

Our engineers ensure that our devices reflect the state of the art through continuous development. Nevertheless, misuse or misconduct can endanger your safety. Please observe the following for a successful use of the device:

	<p>Only authorised and instructed personnel can carry out transport, operation, maintenance and repair of the device. The operator must ensure that the operating personnel take note of these instructions.</p> <p>Please read these instructions before operating the device, and observe the safety precautions to avoid injury!</p> <p>Store this manual in a safe place! These instructions are to be regarded as a component of the product!</p> <p>Adhere to all product notes!</p> <p>Modifications or conversions that the operator carries out at the device without the consent of the manufacturer, can lead to new safety hazards or to the loss of warranty claims.</p> <p>Observe the manufacturer's instructions. Contact the manufacturer in case of any uncertainty: Tel: +49 2541-84841-0 E-mail: info@teka.eu</p>
---	---

2. Description of the system elements

2.1. Illustration of the system elements

Installation example:

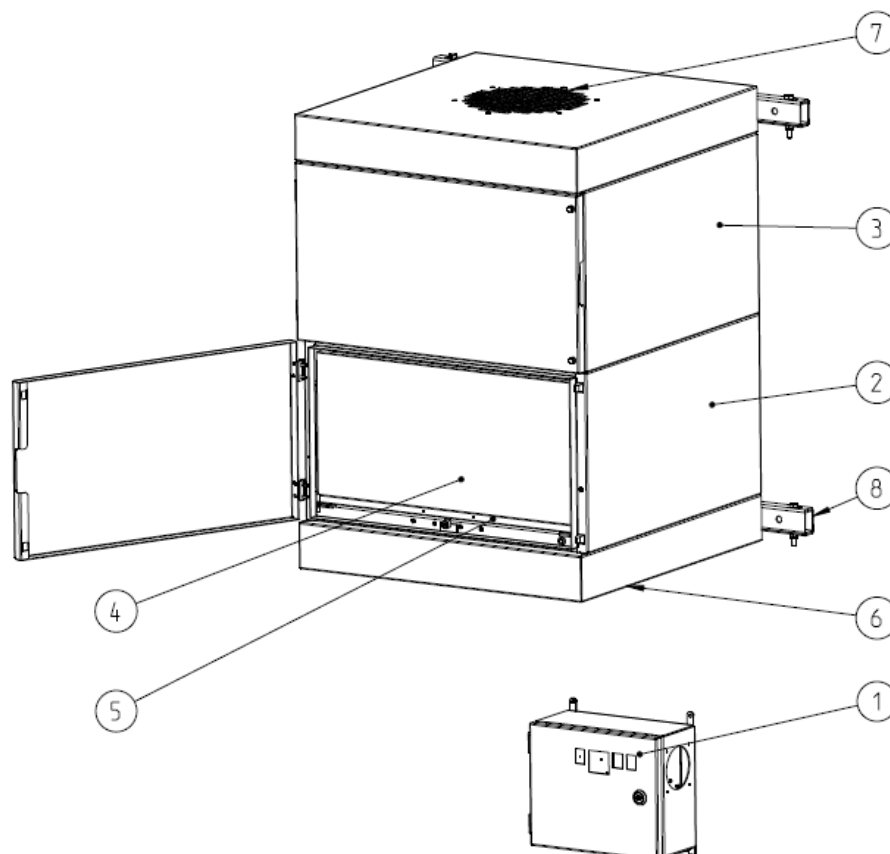

Z.Nr. 12471704

Pos.1	Operating panel of the control	Pos.6	Suction nozzle (CareMaster 1: 1x, CareMaster 2: 2x)
Pos.2	Particle filter housing	Pos.7	Exhaust grille
Pos.3	Fan housing	Pos.8	Wall console
Pos.4	Particle filter		
Pos.5	Prefilter mat (into guide frame)		

2.2. Functionality of the system

The filter unit serves to suck off and filter polluted air (according to the intended use). First of all, the coarse particles are separated at the prefilter mat in the filter section of the unit. The subsequent particle filter cleans even fine smokes and dusts. An automatic filter monitoring indicates when a cleaning or a replacement of the filters is necessary. The purified air is led back into the working room.

2.3. Intended use

The device is intended for commercial use. If the device is made publicly accessible, it must never be operated unsupervised by authorized personnel, authorized by the operator.

The filter unit is mainly used to extract and filter dust and fumes.

	WARNING
	<p>Improper use can damage parts and be a danger to life and limb! The device must not be used for the extraction of oil-laden welding fume, explosive dust and gases, hybrid mixtures, glowing or burning substances, gases, water, etc. The device must not be operated in explosive zones.</p> <hr/> <p>Dangers arising from fire. If the sucked medium is combustible fume or dust, the operator must determine beforehand which fire protection measures are to be taken.</p>

2.4. Residual risk

	CAUTION
	<p>Danger due to possible hazardous materials in the exhaust air flow. Because the unit does not monitor the quality of the air in the exhaust air flow, we recommend that you always guide the exhaust air flow exiting our unit to areas (e.g. to the outside into the open air) in which there is no danger to any living being. To do this, it is necessary to fit a suitable exhaust air line at the filter unit.</p>

3. Safety instructions

3.1. Definition of the hazard symbols

The device is constructed according to the state of the art and the recognised safety regulations. Nevertheless, during use threats to life and limb of the user or other persons may arise. The impairment of the machine or other property are also possible. In these instructions we warn by using corresponding indications.

	WARNING WARNING These instructions are made in case of risks that can lead to <u>injury or death</u> .
---	--

	CAUTION CAUTION These instructions are made in case of risks that can lead to <u>injury</u> .
---	---

	NOTICE NOTICE These instructions are made in case of risks that can lead to <u>material damages</u> .
--	---

	Information notes are no hazard warnings; they call attention to useful information.
---	--

3.2. General safety instructions

	WARNING Dangers arising from improper use / unauthorised operations. The operator must ensure that their authorised personnel are familiar with all the safety indications in this manual in advance. The operator is responsible for ensuring that all work is carried out by authorised and qualified personnel. We therefore recommend using the training protocol on the last page for that purpose (see chapter "Training protocol"). Laymen are allowed to operate the device after having received the necessary instructions. But they are not allowed to carry out any installation, repair or maintenance work. Dangers arising from fire. In case of fire, if possible, switch the unit immediately off or disconnect it from the power supply. Fire extinguishing measures which the operator is obliged to determine beforehand must be initiated immediately.
---	--

	WARNING
	<p>Dangers arising from electricity. The operator must ensure that electrical plants and equipment are only built, modified and maintained by a qualified electrician or under the direction and supervision of a qualified electrician. Do not work on components if you are not sure that these are disconnected. If necessary, disconnect the device from the electric power supply and secure it against unauthorized restarting.</p>

4. Storage, transport and installation of the device

	WARNING
	<p>Risk of injury from tilting or unmounted components when stored or transported. The device must be secured against tilting and slipping when it is stored or transported. Do not stand under or next to the floating load. Lift trucks, forklift trucks and transport cranes must have a sufficient minimum load bearing capacity.</p> <hr/> <p>Risk of injury arising from the falling unit at its destination. The unit must be firmly mounted to the destined wall. The wall must be vibration-free and vertical. The operator must check if the wall provides a sufficient bearing capacity.</p>

	NOTICE
	<p>Damage or functional impairment of the unit due to climatic influences. The unit must be stored in a dry place and protected against moisture during transport. As a matter of principle, the filter unit is not designed to be installed outdoors. In this case contact the manufacturer in order to find out if a capping or a trace heating system are necessary.</p>

4.1. Mounting height

The mounting height of the filter unit depends on the capturing element connected to the filter unit.

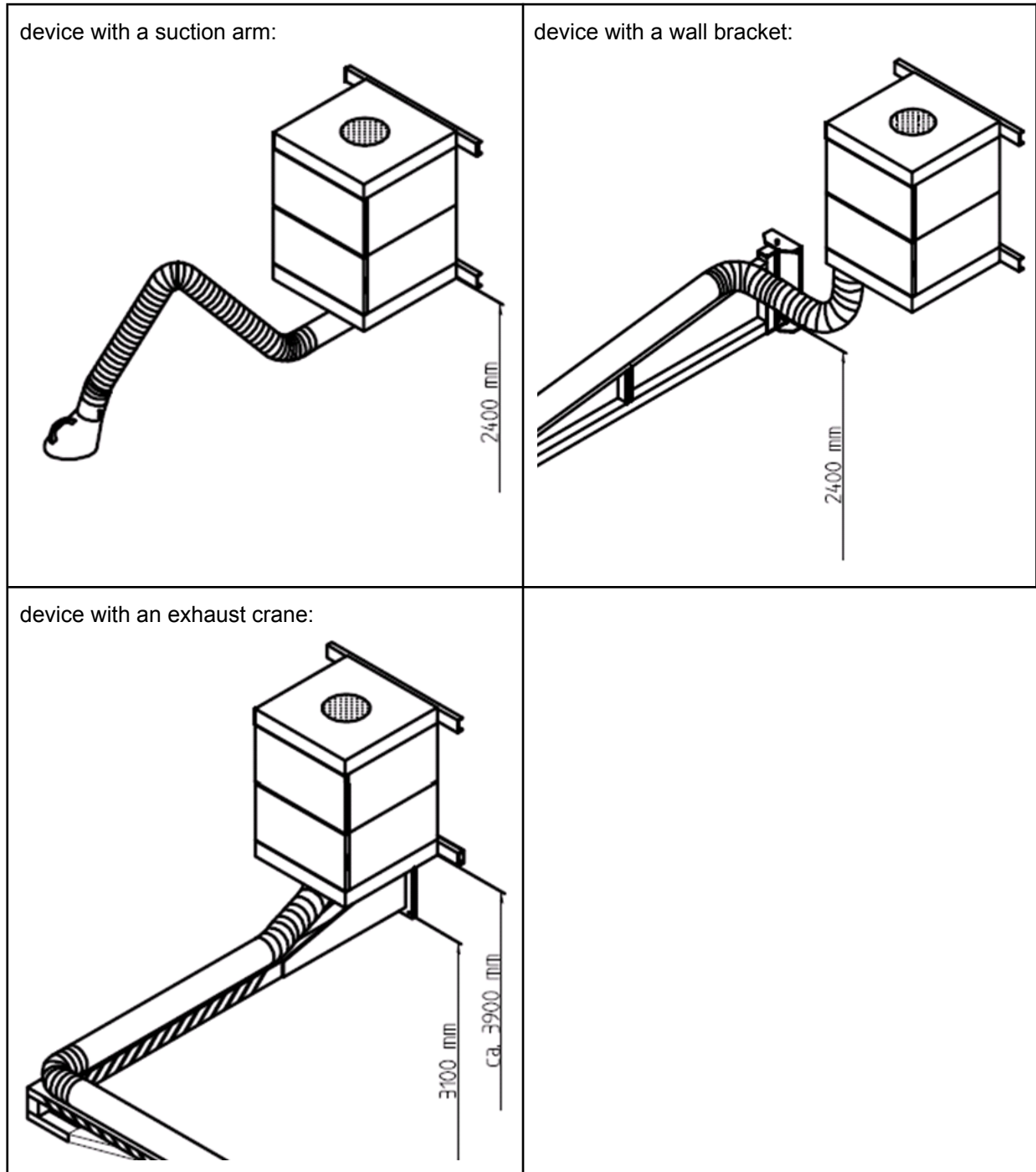

4.2. Mounting of the unit to the wall

Wall brackets are already attached to the filter unit upon delivery.

- The two other wall brackets must be screwed to the wall. Pay attention to an identical distance "X".

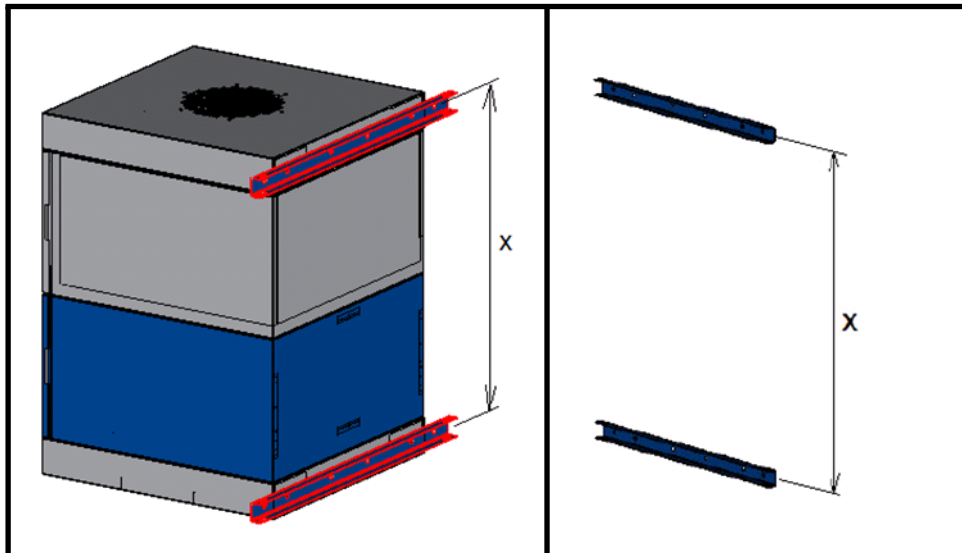

- Put the filter unit with its wall brackets on the wall brackets attached to the wall and screw them by means of the delivered screws.

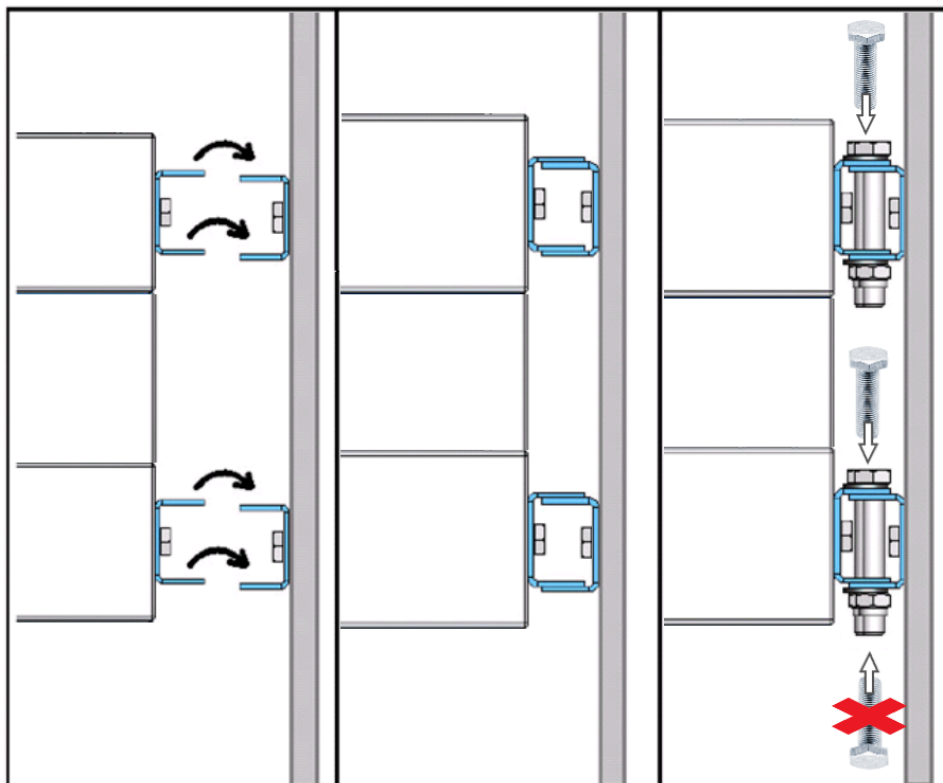

5. Commissioning

	WARNING
<p>Dangers arising from a defective condition of the unit. Make sure that the measures described in this chapter are completed before the commissioning of the unit. All doors of the unit must be closed and all necessary connections must be attached before turning the unit on. Do not operate the unit if any components are defective, missing or damaged. Check the orderly condition of the unit before switching it on. The unit must not be operated without a filter element.</p>	

	NOTICE
<p>Damaged supply lines. Make sure that the supply lines are protected against damage by forklift trucks and similar events. Protect all supply lines from heat, moisture, oil and sharp edges.</p>	

5.1. Connecting an extraction element

For extracting the contaminated air - according to the intended use - the provided extraction element (e.g. suction arm, suction hose, ...) must be connected at the suction nozzle (see chapter 2.1).

	The assembly of a suction arm is described in the separate operating manual.
---	--

When using a detection element with extraction hood, the extraction hood must track the welding seam, possibly taking advantage of the thermally induced welding fume movements.

CAUTION However, it is important to ensure that connections between the workpiece and the extractor hood (and generally between the workpiece and filter device) are avoided, so that, if necessary, the welding current cannot flow back through the protective conductor of the filter device to the welding machine.

5.2. Electrical connection

	WARNING
<p>Risk of electric shock. Electrical plants and equipment may only be built, modified and maintained by a qualified electrician or under the direction and supervision of a qualified electrician. Do not work on live electrical components and elements if you are not sure that these are indeed disconnected. If necessary, disconnect the device from the mains. The operator is responsible for a potential-free balance of the equipment. If the unit is equipped with a frequency converter, then it may only be operated on networks with an AC/DC sensitive RCCB. The AC/DC sensitive residual current circuit breaker (type B) must tolerate at least a permissible residual current of 100mA. For frequency converter operation, the cross section of the protective conductor</p> <ul style="list-style-type: none"> • must be at least 10mm², • and must be at least equal to the size of the operator side outer conductor cross-section. 	

	NOTICE
<p>Electric malfunction possible in cause of an incorrect power supply. Pay attention to the admissible supply voltage. Please observe the specifications on the type plate.</p>	

- Mount the housing of the external control (if it is not mounted on the device itself) close to the device on the wall or at any other appropriate mounting point. Or mount the control together with a cabinet console on a suitable surface, for example using lag bolts or heavy-duty anchors.

⚠ WARNING The housing is not suited for outdoor installation.

- Connect all visible cables and hoses according to their functions. When delivered they are labelled according to their functions. When connecting to the control, please observe the specifications on the circuit diagram which is attached to the control.
- Connect the unit to the power supply.
- Check if the direction of fan rotation is correct. A wrong rotation direction can be identified thanks to the sticker stuck to the fan scroll which is showing the direction. Compare the rotation direction on the sticker to the rotation direction of the motor cooling fan when the motor is running down after being switched off. If the motor rotates in the wrong direction, disconnect the device from the power supply and exchange two phases at the supply line to the control.

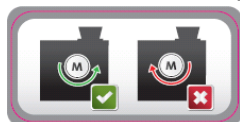



⚠ CAUTION When the fan rotates in the wrong direction, the extraction capacity is reduced.

6. Operating the system

6.1. Explanation of the operating elements

Operating elements for the device control		
Representation	Designation	Description / function
	ON-OFF-switch	By means of this switch, the device is switched on and off. i When the device is switched off, it is <u>not</u> disconnected from the power supply.

Operating elements for status and error messages		
Representation	Designation	Description / function
	Signal lamp "red"	Flashing up means that the air-flow rate of the device is not sufficient anymore. Filter elements must be cleaned or replaced. When using extraction elements with a suction hood, it is possible that the throttle valve(s) in the suction hood are closed. In this case open the throttle valves.
	Indicator lamp "green"	Flashing up means that the device is in operation.
	Operating hour counter	The number of operation hours during which the device was in operation is shown.

7. Maintenance

In accordance with national regulations, the operator is obliged to carry out repeat and functional tests. Unless otherwise specified by national regulations, we recommend regular visual inspections and functional tests of the device as described in the chapter "Maintenance intervals".



You find the chapter "Maintenance intervals" at the end of the document. The general maintenance (visual inspection, etc.) is also explained there.

In the chapter "Maintenance intervals" there is information on the maintenance intervals of the filter elements. But these are only recommendations. Depending on the application (multi-shift operation, dust generation, ...) it may be necessary for the operator to change the maintenance intervals.

In this chapter the maintenance work which is caused by wear caused during operation is described.



WARNING

Work on the open system entails the risk of electrical shock or accidental restart the system. Both pose a danger to life and limb.

When cleaning and servicing equipment during the replacement of parts or when changing to another function, set the device to maintenance condition first (see chapter "Reset to maintenance state").

A recommissioning of the device must only occur if it is ensured that the device is functionally equivalent to the original state.

Dangers to life and limb when non-original spare parts are used

Only original TEKA spare parts must be used.



CAUTION

Hazards to the respiratory tracts are possible.

All maintenance work must only be carried out in well-ventilated rooms and while wearing an appropriate respiratory mask! We recommend: respiratory protection half mask DIN EN 141/143 protection level P3. For all maintenance work ensure a cautious handling of filter elements and components in order to avoid whirling up dust.



The operator is obliged to store and dispose of the collected dust in accordance with national or regional regulations. For all maintenance or cleaning work please refer to the applying environmental regulations. Pollutants and filter elements must be disposed of or stored according to the regulations as well. If you have any doubts, we recommend contacting a disposal contractor in your area.

7.1. Reset to maintenance state

- Switch off the unit. Secure the unit against unauthorized restarting during maintenance.

⚠ WARNING When the device is switched off, it is not disconnected from the power supply.

- After completion of all maintenance work the unit can be switched on again.

7.2. Replacing the prefilter mat

The prefilter mat is installed upstream to the particle filter and separates the coarse particles. This extends the service life of the particle filter.

The prefilter mat must be changed after a certain number of operating hours. The time depends on the amount of accumulated dust, and therefore cannot be determined beforehand. At the latest, the prefilter mat must be changed when changing the particle filter.

	CAUTION
Whirling up dust is possible. The prefilter mat is a disposable filter element. Do not try to clean the filter element.	

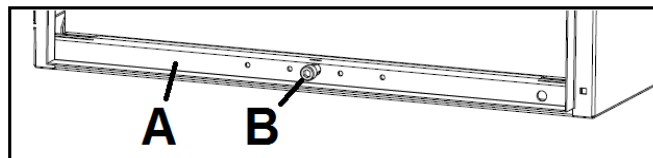

- Open the service door of the particle filter housing (see chapter 2.1).
- Lower the lifting device (A) by turning the clamping screw (B). Therefore, use the hexagon key that is located on the right of the clamping screw.
- Carefully pull the entire filter pack, incl. the insert frame (see chapter 2.1) out of the housing.
- Remove the prefilter mat from the insert frame and dispose of or store it according to the regulations.
- Put a new prefilter mat into the insert frame.
NOTICE Only use TEKA spare filters. Otherwise the proper functioning of the unit is not guaranteed, and there is a danger to life and limb.
- Push the filter pack back into the dust collecting housing as far as it will go.
- Elevate the lifting device by turning the clamping screw so that the upper filter element is pressed tightly against the above housing.
- Close the service door.

7.3. Replacing the particle filter

Replacing the particle filter is necessary when the device control signals the corresponding error. (see chapter "Description of the control elements")



CAUTION

Whirling up dust is possible.

The particle filter is a disposable filter element. Do not try to clean the filter element.



When replacing the particle filter, the prefilter mat must be replaced as well.

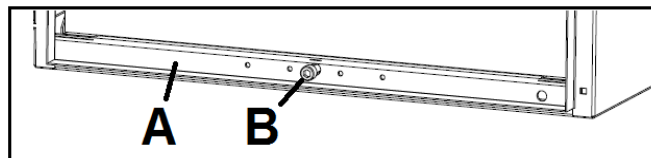



- Open the service door of the particle filter housing (see chapter 2.1).
- Lower the lifting device (A) by turning the clamping screw (B). Therefore, use the hexagon key that is located on the right of the clamping screw.
- Carefully pull the particle filter (see chapter 2.1) out of the housing.
- Push the new particle filter back into the particle filter housing as far as it will go.
NOTICE Only use TEKA spare filters. Otherwise the proper functioning of the unit is not guaranteed, and there is a danger to life and limb.
- Elevate the lifting device by turning the clamping screw so that the particle filter is pressed tightly against the above housing.
- Close the service door.

8. Dismantling / Disposal

Only authorised personnel may disassemble the machine.

	WARNING Dangers arising from electricity. Before the dismantling of the machine it has to be disconnected from the power supply and all supply lines.
---	---

	CAUTION Whirling up dust is possible due to the deposited dust. During all work a suitable respiratory protection and protective clothing have to be worn.
---	--

	The operator is obliged to store and dispose of the collected dust in accordance with national or regional regulations.
---	---

9. Diagnostics and troubleshooting

A list of possible system errors is provided in the table.



Faults indicated by control elements are explained in the chapter "Description of the control elements".

A recommissioning of the device must only occur if it is ensured that the system is functionally equivalent to the original state. Repairs may only be carried out by TEKA personnel or, after consultation with TEKA GmbH, by the personnel authorised by the operator.

Adhere to the instructions in the chapter "Safety instructions" and "Maintenance" when carrying out any repairs. If in doubt, contact our TEKA service department:

Tel: +49 2541-84841-0
E-mail: info@teka.eu

Fault	Cause	Removal
System does not start.	Plug power supply is missing or incorrectly inserted.	Plug connector check power supply / plug in correctly.
	No power at outlet.	Check the mains, remove error if possible.
Dust at the service door of the filter housing.	The door is not correctly closed.	Close the door.
	The seal between the service door and filter housing is damaged.	The seal must be replaced.
	Escape of dust at the hinge.	The hinge must be reoriented or replaced.
Suction power too low (smoke hardly extracted).	Filter element is saturated.	Replace the filter package, dispose of old filter properly!
	Damage at the extraction elements.	Replace the extraction elements.
	The motor rotates in the wrong direction.	The rotating field of mains connection point must be changed.
	Suction line contracted.	Check and fix.
	Exhaust line contracted.	Check and fix.
The system is very noisy.	The motor rotates in the wrong direction.	The rotating field of mains connection point must be changed.
	The unit is untight.	Check and fix.

10. List of spare parts

	WARNING
Dangers to life and limb when non-original spare parts are used. Only original TEKA spare parts must be used.	

Filter element	Article no.
Prefilter mat "M5" (10 pieces / 610 x 610 x 20 mm)	10032
Particle filter "H13" (610 x 610 x 292+6)	10030
Particle filter "F9" (610 x 610 x 292+6)	10029

11. Technical data

Version		CareMaster Wand - 1	CareMaster Wand - 2
Supply voltage	V	230 / 400 / 500	230 / 400 / 500
Frequency	Hz	50	50
Type of current	Ph	1 / 3 / 3	1 / 3 / 3
Engine power	kW	1,5	2,2
Air flow volume max.	m³/h	1800	3500
Negative pressure max.	Pa	3000	2500
Protection class		IP54	
ISO class		F	
Extraction performance	%	> 99	
Width	mm	665	665
Depth	mm	681	681
Height	mm	930	930
Weight	kg	129	142
Sound pressure level	dB(A)	72	74
Allowed ambient temperature	°C	+5 to +35 (during operations) -10 to +40 (during transport and storage)	
Max. temperature of polluted air at the capture point	°C	+50	
Allowed max. humidity	%	70	

12. EC declaration of conformity

according to the Machinery Directive 2006/42/EG, Annex II, 1 A

TEKA Absaug- und Entsorgungstechnologie GmbH

Millenkamp 9, D-48653 Coesfeld

Tel.: +49 2541-84841-0

E-Mail: info@teka.eu

Internet: www.teka.eu

Designation of the device: CareMaster Wall 1 / CareMaster Wall 2

We hereby declare under our sole responsibility that the product mentioned above, from the serial number A22600010011001 resp. P57300010011001 on, conforms to the following directives:

Machinery Directive: 2006/42/EG

Electromagnetic Compatibility: 2014/30/EU

RoHS directive: 2011/65/EU

This declaration will become void if the device is exposed to modifications that are not approved by the manufacturer in written form.

Authorized representative for the technical documentation:

TEKA Absaug- und Entsorgungstechnologie GmbH, Millenkamp 9, D-48653 Coesfeld

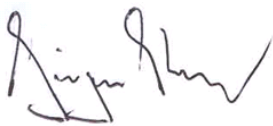

(Jürgen Kemper, managing director)

Coesfeld, 3rd January 2023



13. Training protocol

Designation of the device: CareMaster Wall 1 / CareMaster Wall 2

(This form can be used by the operator to document the training of the employees. Training should be performed by authorized personnel only. Refer to the instructions in Chapter "Safety Instructions")

By his signature, the employee confirms that he has been instructed regarding the following items:

Instruction	completed
Description of the device	
Operation and application of the device	
Explanation of the safety instructions	
Behavior in case of fire	
Explanation of the operation elements	
Change and dedusting of the filter elements	
Appropriate disposal	
Maintenance works / Maintenance intervals	

Name of the employee (legible)	Signature

Introduction through (legible):	
Signature:	

14. Maintenance intervals

14.1. Usage-related maintenance

The described maintenances become necessary through the demands of the system operations. The maintenance intervals are recommendations. Depending on the application (multi-shift operation, dust generation, ...) it may make sense for the operator to change the intervals of maintenance, replacing and cleaning.

Maintenance work must always be documented by means of a protocol.

The approach of the maintenance measures is described in chapter "Maintenance".

Maintenance work	Chapter	Maintenance interval	
		recommended by TEKA	determined by the operator
Replacing the particle filter	7.3	The saturation of the particle filter is automatically monitored by the filter unit and thus is not subject to a maintenance interval. The filter unit triggers an alarm when a replacement of the particle filter is necessary.	
Replacing the prefilter mat (or check the degree of pollution)	7.2	monthly	

14.2. General maintenance

The described maintenances are independent from the demands of the system operations.

The operator is obliged to carry out repeated inspections and functional tests according to national regulations. If not otherwise covered by national regulations, the described maintenance intervals must be respected.

Maintenance work must always be documented by means of a protocol.

Maintenance work	Chapter	Maintenance interval
Visual inspection of the device	14.2.1	weekly
Functional test of the device	14.2.2	monthly
Electrical test of the electrical lines and earthing connections	14.2.3	annually

14.2.1. Visual inspection of the device

Visual inspection: Observation that there are no visible safety-related defects.

	WARNING
Danger arising from the ready to operate condition of the device. Follow the procedure as described in the chapter "Set to maintenance state".	

The following steps must be carried out in the course of the visual inspection:

- Check if all required pipeline elements, cable connections and hoses are connected to the filter unit
- Check all electrical earthing connections and cables for visible damages.
- Ensure that all parts are firmly connected.
- Check all connection points of the filter unit for escaping dust.
- Check all metal parts for corrosion or damages / changes of the coating.
- Visual inspection of the control and operating elements as well as the outside running cables for damages.

14.2.2. Visual inspection of the pipelines for dust deposits

	NOTICE
Possible material damage due to faulty condition of the unit. Carry out a visual inspection before the functional test of the device as described in the previous chapters. The work as described in the chapter "Commissioning" must be finished.	

The following steps must be carried out in the course of the functional test:

- Switch on the device.
- Pay attention to extraneous noises or vibrations during the device's operation.
- A functional test should always be carried out with a connected / producing machine tool. Check if the collection of the fume or dust is sufficient. (Visual inspection).

14.2.3. Visual inspection of the pneumatic pipes

	WARNING
Danger arising from electricity. The operator is responsible for ensuring that all work on electric components is carried out by authorised and qualified personnel.	

The device is subject to regular electrical checks by the operator of the device, and are subject to national standards of the different countries.

The here recommended maintenance interval complies with the in Germany applying "Regulation 3 of the German Social Accident Insurance - Electrical plants and equipment" (formerly known as BGV-A3).

The check must only be carried out by a qualified electrician or a person trained in electrics using suitable measuring and test devices. The scope of testing and the methods must be in line with the respective national standard. All contacts in the control cabinet must be checked for tight fit, and must be readjusted if necessary.